



NRG3602



Six 15,000 BTU burners found on the NRG3602 are products of the world-renowned burner manufacturer Ispording, located in Attendorn, Germany.

The 5.2 cubic foot oven is spacious enough to hold multiple dishes at the same time, while the convection feature ensures even cooking temperatures through out the oven cavity.
22,000 Oven BTU Burner.

For searing and broiling recipes, our range boasts a powerful 16,500 BTU Infrared broiler.

Constructed using all 304 stainless steel, the NRG3602 meets the highest standards of both quality and durability, in an industry that demands perfection.

NRG3602 ALL-GAS FREESTANDING RANGE (36 Inch)

Control Panel Features

Manual Oven Control	Yes
Two Tone Control Knobs with Stainless Steel Bezel	7

Cooktop

15,000 BTU Sealed High-Output Burner with 620 BTU Variable Simr	6
Full-Length Grates (front to back)	3
Electronic Ignition with Auto Re-Ignition	Yes

Oven Feathers

Capacity	5.2 Cu. Ft.
Manual Convection Cooking Mode	Yes
Bake Burner	22,000 BTU
Infrared Broiler Burner	16,500 BTU
Broil Pan	Included
Blue Interior	Yes
Racks	2
Oven Lights	2

Additional Features

Four Inch Stainless Steel Backsplash	Yes
Full Stainless Steel Side Panels	Yes
Professional Handle	Yes
Full adjustable -Heavy-Duty Legs	Yes

Specifications

Electrical Rating	120V/60Hz/15 or 20A
Product Weight	364 Lbs.
Shipping Weight (Approx.)	415 Lbs.

Electrical Power Supply Requirements

- Use 120V, 60Hz, properly grounded branch circuit protected by a 15-amp or 20-amp circuit breaker or time delay fuse.

Your range must be electrically grounded in accordance with local codes or, in the absence of local codes, in accordance with the National Electrical Code (ANSI/NFPA 70, latest edition). In Canada, electrical grounding must be in accordance with the current CSA C22.1 Canadian Electrical Code Part 1 and/or local codes. A copy of this standard may be obtained from: The National Fire Protection Association, 1 Batterymarch Park, Quincy, Massachusetts 02269-9101.

Gas Supply Requirements

- Shipped natural gas; accepts standard residential 1/2" NPT gas service line.

Installation of this range must conform with local codes, or in the absence of local codes, the National Fuel Gas Code (ANSI Z223.1, the latest edition). In Canada, installation must conform to the current Natural Gas Installation Code, CAN/CGA-B149.1 and with local codes where applicable. This range has been design-certified by the American Gas Association according to ANSI Z21.1, latest edition and Canadian Gas Association according to CAN/CGA-1.1 latest edition.

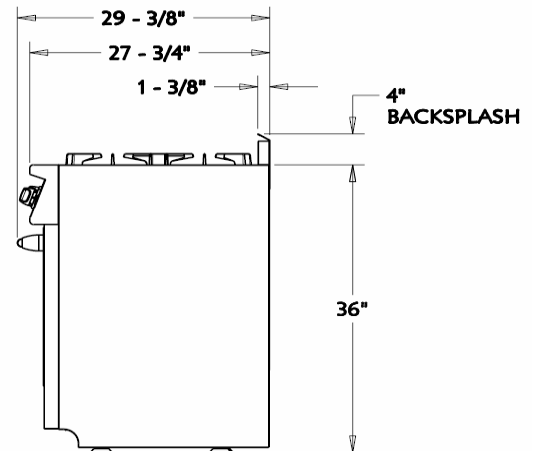
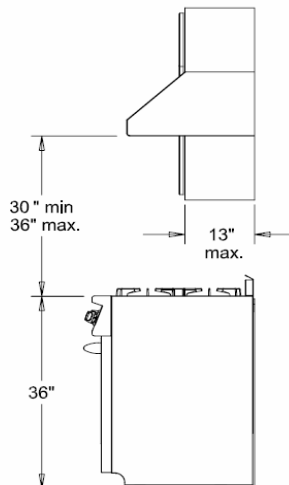
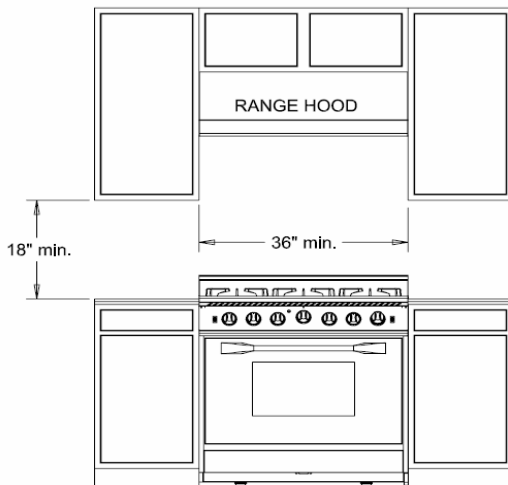
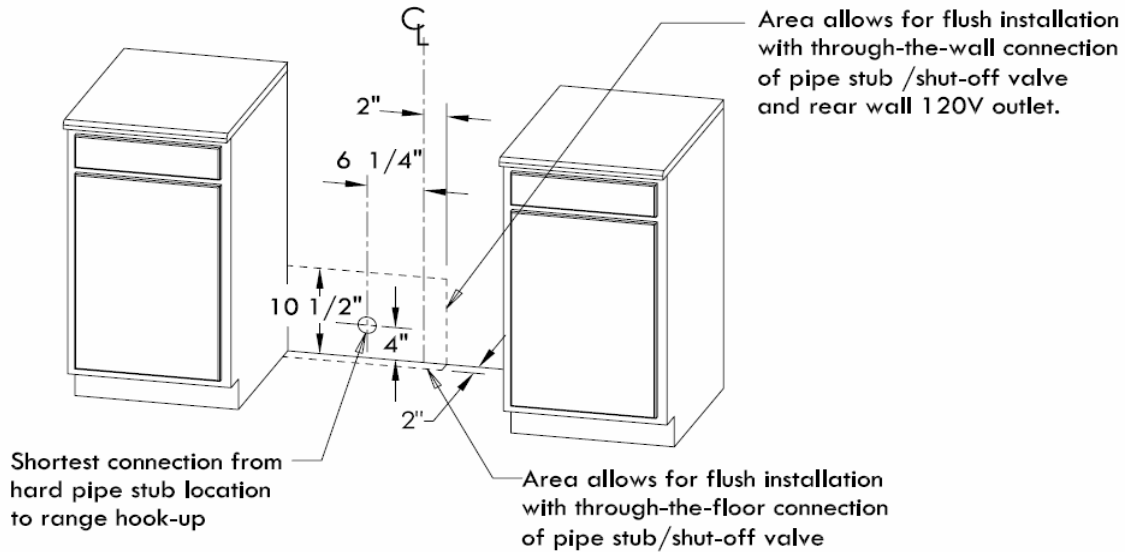

OVERALL DEPTH WITH OVEN DOOR IN FULLY OPEN POSITION = 44 - 1/2"